

Data Highway Plus (Blue Hose®)

The Data Highway Plus (DH+) network is a local area network that is very simple to implement. It is designed to provide simple communication between PLC's, SLC's and PC's.

The Data Highway Plus network allows connection to a maximum of 64 devices per link although 15 or fewer nodes are recommended per link. Devices include:

- PLC-5 and SLC 5/04 programmable controllers
- Color graphics systems
- Personal computers
- Host computers
- Numerical controls
- Programmable RS-232-C/RS-422 devices

A network can be configured with 99 links. With a multi-link network, more nodes in the network are possible.

By placing nodes in the proper link with some nodes and separate from other nodes, the efficiency of message delivery can be improved. Using simple twisted-pair wiring, DH+ can be configured as a trunk-line drop or a daisy-chain topology.

Data Highway Plus (Blue Hose®), Cable Specifications

Blue Hose is a shielded, twisted pair network cable. The cable consists of blue, clear and shield wires. A terminating resistor must be attached across the blue and clear wires at each end of the network. The resistor value depends on the baud rate selected. The cable shield must be connected to chassis ground only at the scanner end of the network.

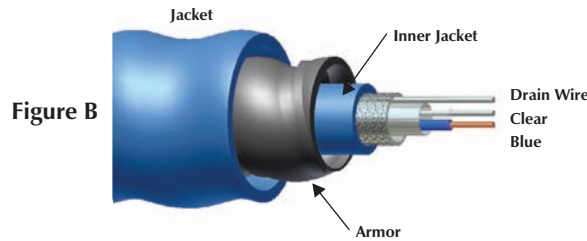
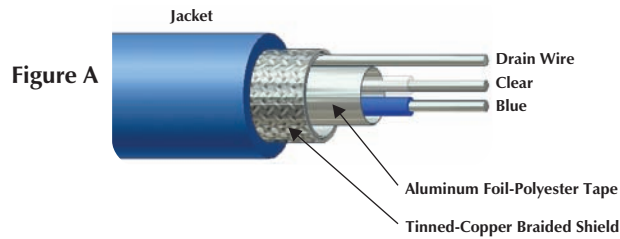







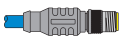

Baud Rate	Maximum Cable Length
57.6 Kbps	10,000 feet (3048 meters)
115.2 Kbps	5,000 feet (1524 meters)
230.4 Kbps	2,500 feet (762 meters)

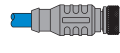
Type	Approvals	Data Pair		Outer Jacket Material Color Nominal O.D.	Shields Type Drain Wire	Bulk Cable Part Number / Weight/300 M	Figure
		AWG Color Code	DCR (/1000 feet) Insulation				
390 AWM 2464 80°C 300 Volts	NEC CC CL2 CEC CC	2/20 AWG BU, Clear	9.5 Ohms PC	PC Blue 6 CC (.238 in)	Braid/Coil 20 AWG	RB51157-*M 36 lbs.	A
391A 60°C 300 Volts	NEC CC CL2 CEC CC CCG FT4 [HLBCD]	2/20 AWG BU, Clear	9.5 Ohms PC	Aluminum Armor/PC Blue	Armor Foil Braid	RB51199-*M 122 lbs. <i>armorfast</i> ®	B

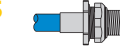
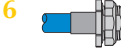
* Indicates length in meters.
Blue Hose is a registered trademark of Belden CDT Inc.
Standard cable lengths are 1.0, 2.0, 4.0, 6.0, 10....15 meters.

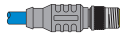
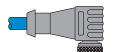
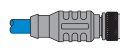
Data Highway Plus (Blue Hose®), Cable and Cordset Selection Matrix

		<i>euromast</i> ®				<i>euromast</i> Bulkhead		
		Pin (Male)		Socket (Female)		Pin (Male)	Socket (Female)	
		1  RSC	3  WSC	2  RKC	4  WKC	5  FSFD	6  FKFD	
 Bare		RSC 39x-*M	WSC 39x-*M	RKC 39x-*M	WKC 39x-*M	FSFD 39x-*M	FKFD 39x-*M	
<i>euromast</i>	Pin (Male)	1  RSC	RSC RSC 39x-*M	RSC WSC 39x-*M	RSC RKC 39x-*M	RSC WKC 39x-*M	RSC FSFD 39x-*M	RSC FKFD 39x-*M
		3  WSC		WSC WSC 39x-*M	WSC RKC 39x-*M	WSC WKC 39x-*M	WSC FSFD 39x-*M	WSC FKFD 39x-*M
	Socket (Female)	2  RKC			RKC RKC 39x-*M	RKC WKC 39x-*M	RKC FSFD 39x-*M	RKC FKFD 39x-*M
		4  WKC				WKC WKC 39x-*M	WKC FSFD 39x-*M	WKC FKFD 39x-*M

See page S4 for dimensional drawings.

* Indicates length in meters.



x Indicates cable type.

For *armorfast*® cable: Change part number (RSC RSC 39-*M to RSA RSA 391A-*M)

For stainless steel connectors: Change part number (RSC RSC 39-*M to RSCV RSCV 39-*M)

Refer to the Cordset Builder at www.turck.com for assistance with cordset/cable combinations.

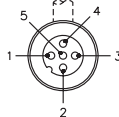
Standard cable lengths are 1.0, 2.0, 4.0, 6.0, 10....15 Meters.

<i>euromast</i>	Pinouts	<i>euromast</i>
Male 	1. Drain (Shield) 2. Clear (RIO #2) 3. Blue (RIO #1) 4. N/C 5. N/C	Female 

Data Highway Plus (Blue Hose®), eurofast® Cordset and Receptacle Connector Dimensions

Specifications

Housing:	PUR (polyurethane)
Coupling Nut:	Nickel Plated CuZn or Stainless Steel
Contact Carrier:	TPU (Polyurethane) or POM (Nylon)
Contacts:	Gold Plated CuZn
Protection:	NEMA 1, 3, 4, 6P and IEC IP 68
Rated Voltage:	250 V
Rated Current:	4 A
Ambient Temperature:	-40° to +60°C (-40° to +140°F)

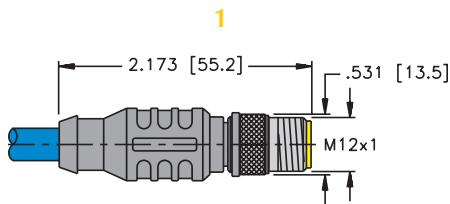

RSC .. **Page S3**

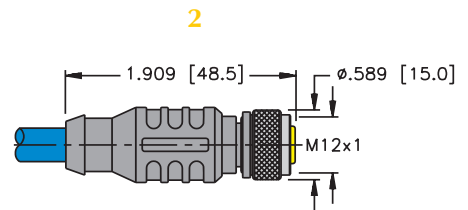

RKC .. **Page S3**

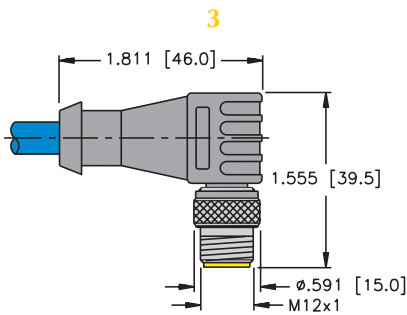

WSC .. **Page S3**

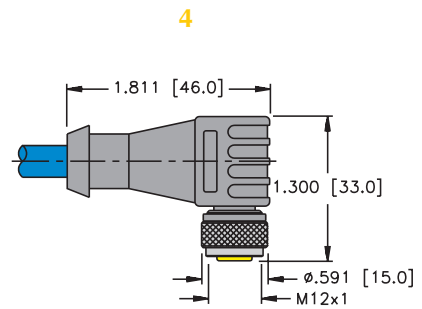

WKC .. **Page S3**

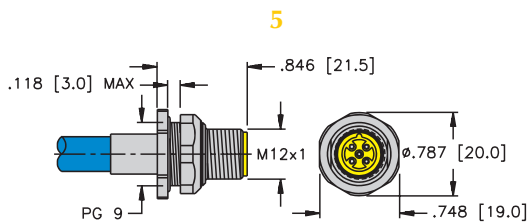

FSFD .. **Page S3**

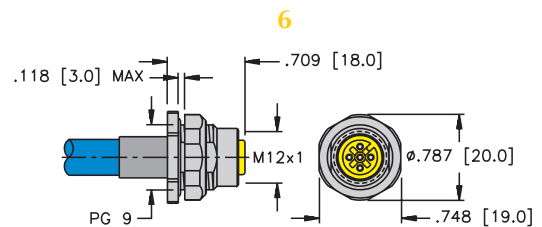

FKFD .. **Page S3**

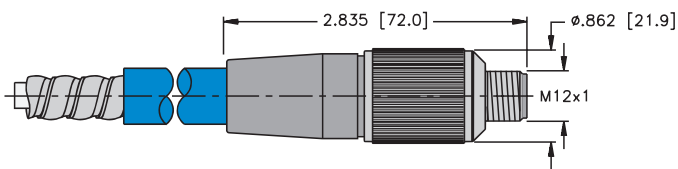

RSA .. **(armorfast® only)**

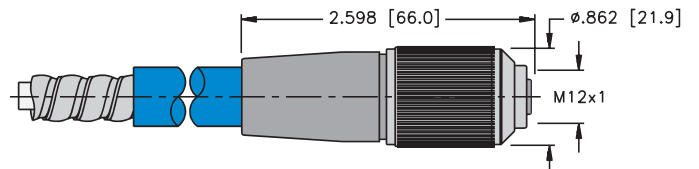

RKA .. **(armorfast only)**

Blue Hose

Notes